



**Ice Machine Parts List for
Series Q1600 Models**

QD1603W

QD1692N

QY1605W

QY1694N

Q1600 CONTROL BOX

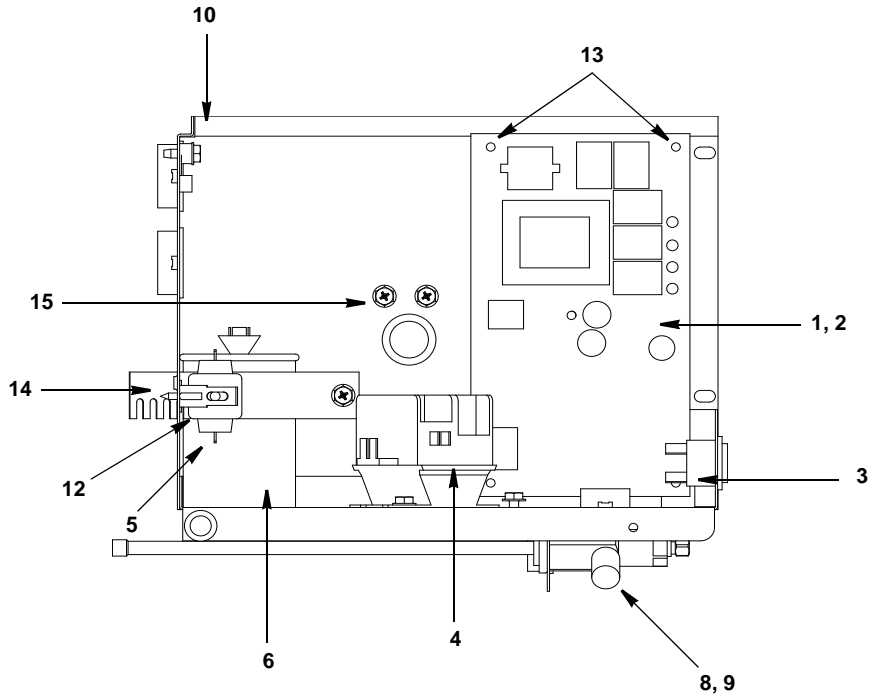

pt1380

DESCRIPTION

DESCRIPTION	PART NO.
1 Control Board (for use with all voltages)	† 76-2782-3
2 7 Amp Fuse – Mounted on Control Board	25-1100-3
3 Toggle Switch Only	23-0134-3
a. Toggle Switch with Wiring Harness Attached	20-3217-3
4 Contactor	
a. 208-230V/60 Hz/1 Ph	24-1035-3
b. 208-230V/60 Hz/3 Ph	20-0116-3
5 P.T.C.R. Compressor Starter.	85-0491-3
6 Compressor Run Capacitor	
a. Used with 208-230V/50-60 Hz/1 Ph (Compressor 76-2687-3)	000000028
7 Wire Harness Control Box To Bulkhead	
a. 208-230V/60 Hz/1 Ph	20-0166-3
b. 208-230V/60 Hz/3 Ph	20-0166-3
8 Refrigeration Service Valve Assembly	83-7324-3
Miscellaneous – Brackets, Screws, etc.	
9 Locknut Used to Mount Refrigeration Service Valves.	† 54-7503-9
10 Control Box	602559-1
11 Control Box Cover (Not shown)	† 76-2852-3
12 P.T.C.R. Compressor Starter Mounting Bracket	85-0495-3
13 Control Board Mounting Supports	43-0225-3
14 Capacitor Mounting Strap	602495-1
15 Screw, #10-24 x .50 Ground.	† 52-0216-9

† Refer to Cross Reference Guide

Q1600 EVAPORATOR COMPARTMENT

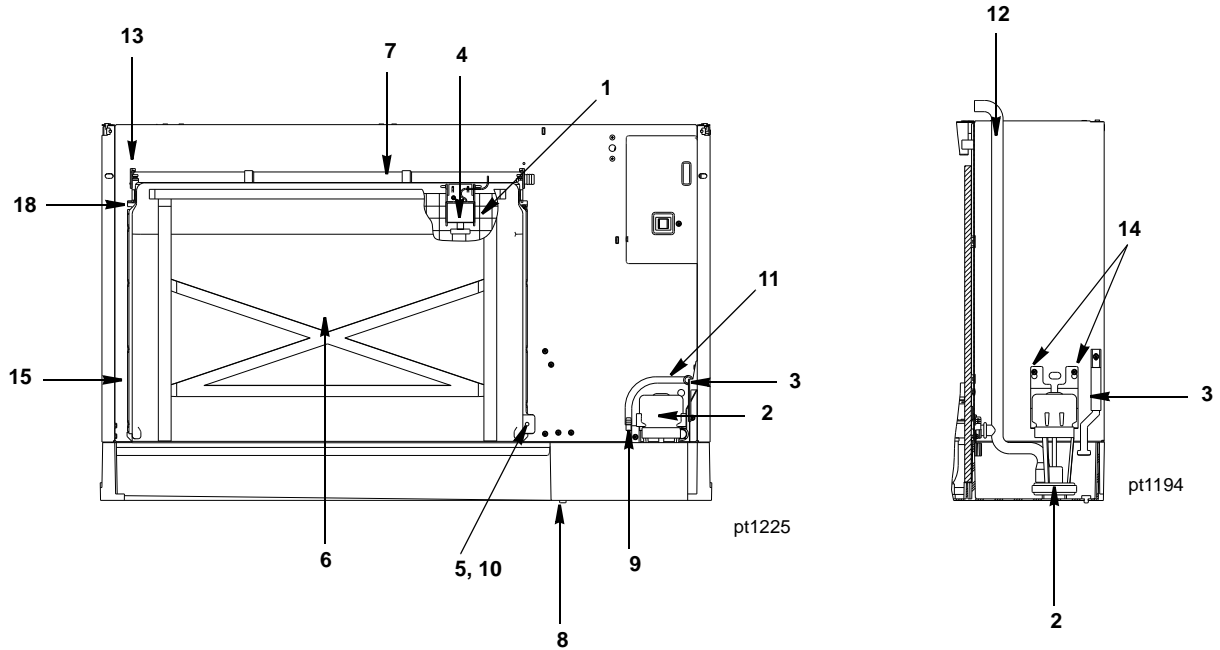

DESCRIPTION

1 Evaporator Assembly

	PART NO.
a. Dice Cube	† 76-2697-9
b. Half Dice Cube	† 76-2698-9
2 Water Pump (208-230V/50-60 Hz)	† 14-8027-9
3 Water Level Probe	25-1129-3
4 Ice Thickness Control Probe	† 76-2781-3
5 Magnetic Bin Switch (Mounted to Evaporator)	† 23-0148-3
6 Water Curtain	40-0474-3
7 Water Distribution Tube	43-0322-3
8 Water Trough Drain Plug	† 43-0062-9
9 Water Inlet Flow Tube	43-0388-3

Miscellaneous – Brackets, Screws, etc.

10 Water Curtain Magnet with Attachment Clip	† 76-2802-3
11 Water Inlet Tubing .375 ID	44-2131-3
12 Tubing (Water Pump Out)	44-2115-3
13 Screw, #8-32 x .63 Nylon Water Distribution Tube Mounting	† 50-0001-3
14 Screw, #10-24 x .50	† 52-0206-9
15 Screw, #10-24 x .750 – Used to Mount Evaporator	† 52-0218-9
16 Base and Water Trough Repair Kit (Not shown)	† 76-2806-3
17 Evaporator Top Molding and Gasket Assembly (Not shown)	76-2801-3
18 Water Curtain Pin Assembly	† 76-2856-3

† Refer to Cross Reference Guide

Q1600 REFRIGERATION COMPARTMENT – COMMON PARTS

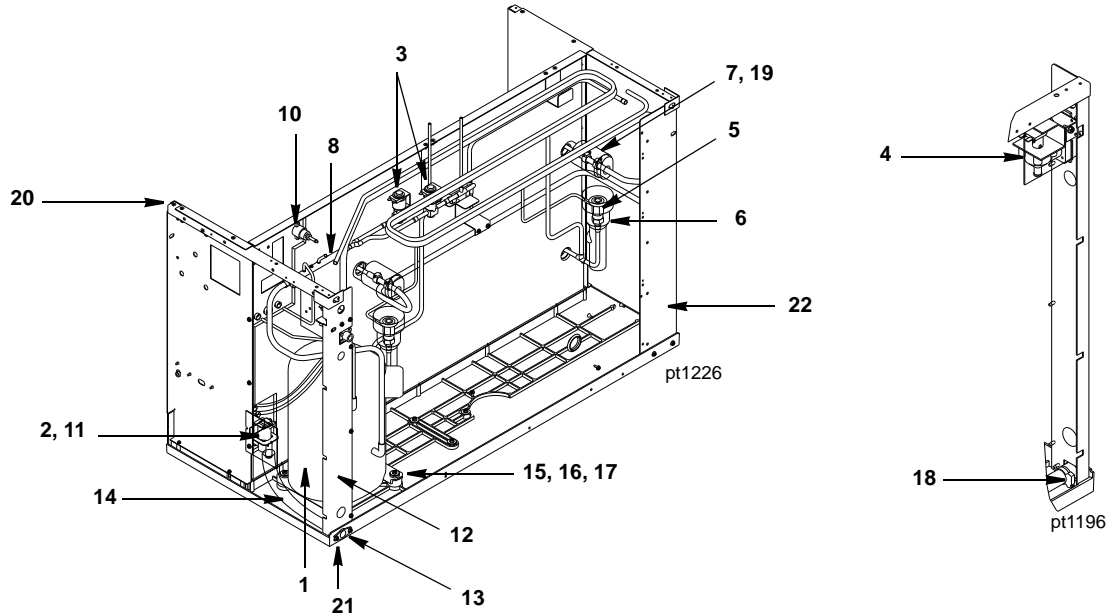

DESCRIPTION

PART NUMBER

1 Compressor	
a. 208-230V/60 Hz/1 Ph	76-2687-3
b. 208-230V/60 Hz/3 Ph	76-2688-3
2 Water Dump Valve	
a. Dump Valve, 208-230V/50-60 Hz	000001768
b. Dump Valve Rebuild Kit	No Longer Available
3 Hot Gas Valve	
a. Hot Gas Valve Including 208-230V/50-60 Hz Electrical Coil	76-3010-1
b. Hot Gas Valve 208-230V/50-60 Hz Coil Only (Alco)	† 24-0448-3
c. Hot Gas Valve 208-230V/50-60 Hz Coil Only (Danfoss)	000002049
4 Water Inlet Valve	
a. Water Inlet Valve Including 208-230V/50-60 Hz Coil	76-0113-3
5 Expansion Valve	76-0159-3
6 Expansion Valve Body Insulation Boot	40-0036-3
7 Expansion Valve Bulb Insulation Boot	40-0720-3
8 Manifold Strainer (in front of hot gas valve)	82-5097-3
9 Water Pump Electrical Wire Lead (Not shown)	† 20-7810-3
10 High Pressure Cut-out (Auto Reset)	† 20-0124-3
Miscellaneous – Brackets, Screws, etc.	
11 Dump Valve Mounting Bracket	601597-1
12 Right Corner Post Weldment	602204-1
13 Water Drain Female Wing Adapter	87-0608-3
14 Water Drain Vinyl Tubing, .625 ID	† 44-2038-3
15 Compressor Mounting Rubber Grommet	† 85-0306-9
16 Compressor Mounting Washer	† 55-7309-9
17 Compressor Mounting Bolt	† 50-3773-9
18 Clamp, Water Drain	† 56-5070-9
19 Clamp, Expansion Valve Bulb	† 56-5052-9
20 Screw, #10-24 x .50	† 52-0209-9
21 Screw, #10-24 x .75	† 52-0218-9
22 Left Corner Post Weldment	604514-1
23 Terminal Block	20-0614-3

† Refer to Cross Reference Guide

Q1600 REFRIGERATION COMPARTMENT – WATER COOLED

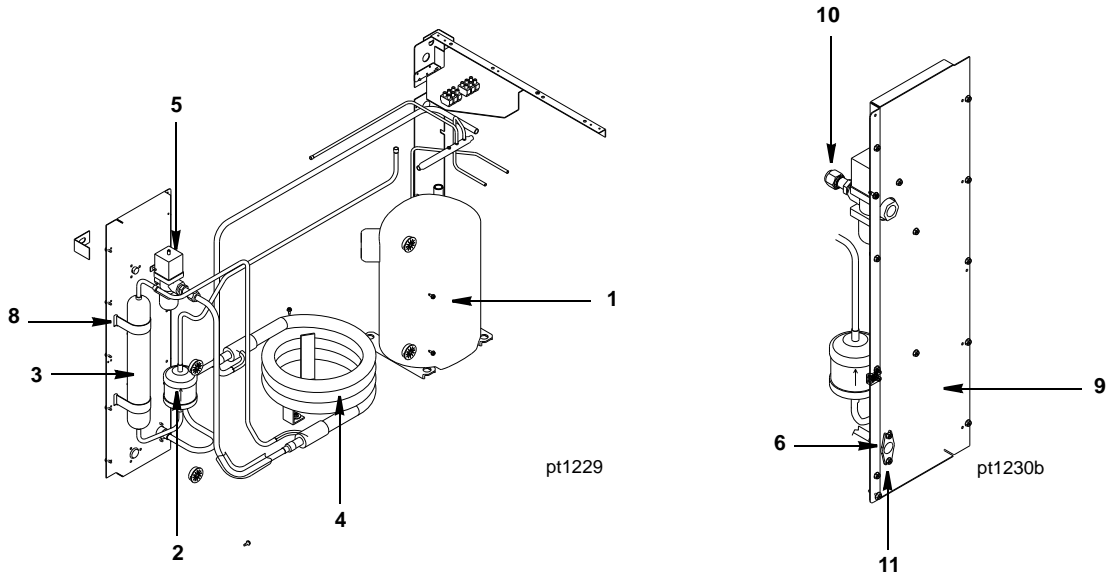

DESCRIPTION

	PART NO.
1 Compressor (Refer to COMMON PARTS Page)	Page 4
2 Drier	89-3027-9
3 Receiver	89-0035-3
4 Water-Cooled Condenser	† 000001508
5 Water Regulating Valve	83-7212-3
6 Water Drain Female Wing Adapter	87-0608-3
7 Wiring Harness (Not Shown)	
a. 230V/60HZ/1Ph	20-0179-3
b. 230V/60HZ/3Ph	20-3196-3

Miscellaneous – Brackets, Screws, etc.

8 Receiver Strap	600054-1
9 Back Panel	601905-1
10 Water Coupling	83-3419-3
11 Screw, #10-24 x .50	† 52-0206-9

† Refer to Cross Reference Guide

Q1600 REFRIGERATION COMPARTMENT – REMOTE

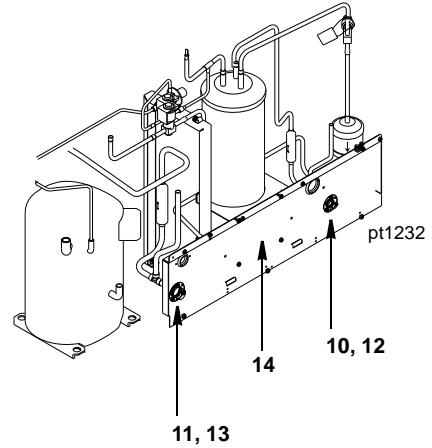
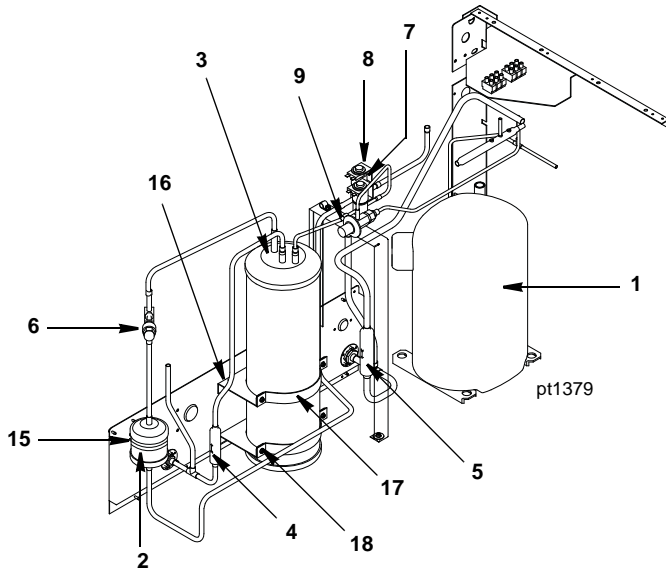

DESCRIPTION

		PART NO.
1	Compressor (Refer to COMMON PARTS)	Page 4
2	Drier	89-3027-9
3	Receiver	† 76-2958-3
4	Magni-Check Valve.	† 83-7314-9
5	Magni-Check Valve.	† 83-7315-9
6	Refrigeration Service Valve	† 83-7316-9
	a. Cap for Refrigeration Service Valve	56-5075-3
7	Harvest Pressure Regulating Solenoid (HPR) Valve	
	a. HPR Valve Including 208-230V/50-60 Hz Electrical Coil	76-3006-1
	b. HPR Valve 208-230V/50-60 Hz Coil Only (Danfoss).	000002049
	c. HPR Valve 208-230V/50-60 Hz Coil Only (Alco).	24-0448-3
8	Liquid Line Solenoid (LLS) Valve	
	a. LLS Valve Including 208-230V/50-60 Hz Electrical Coil	76-3010-1
	b. LLS Valve 208-230V/50-60 Hz Coil Only.	† 24-0448-3
9	Harvest Pressure Regulating Valve (HPR)	† 83-6779-3
10	Coupling – Male, 5/8-18	† 83-6034-3
11	Coupling – Male, 1-1/6-12	† 83-6035-3
Miscellaneous – Brackets, Screws, etc.		
12	Coupling Mounting Flange for 5/8-18	83-6005-3
13	Coupling Mounting Flange for 1-1/16-12	83-6006-3
14	Back Panel	601905-1
15	Drier Plastic Tie.	† 56-5035-9
16	Receiver Mounting Bracket.	600056-1
17	Receiver Mounting Strap	630721-4
18	Screw, #10-24 x .50	† 52-0206-9

† Refer to Cross Reference Guide

Q1600 PANELS

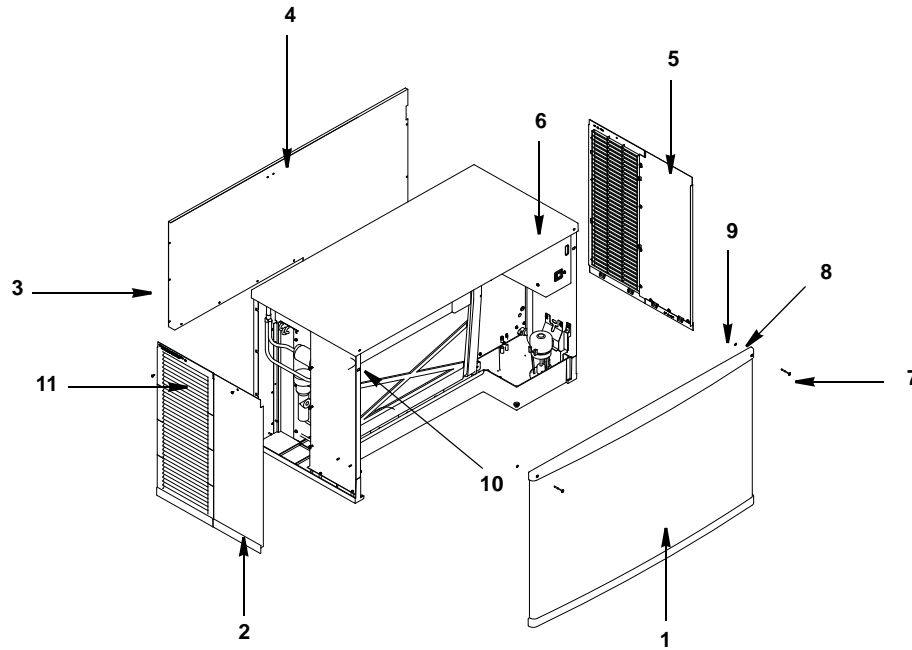

pt1378

DESCRIPTION

	PART NO.
1 Front Panel Assembly	76-2879-3
2 Left Side Panel	† 76-2859-3
3 Back Panel, Water	602599-1
4 Back Panel, Remote	602607-1
5 Right Side Panel	† 76-2860-3
6 Top Cover	43-0332-3

Miscellaneous – Brackets, Screws, etc.

7 Front Cover Screw	† 51-1901-9
8 Front Cover Washer	† 55-7338-9
9 Front Cover Screw Retainer	† 56-4827-9
10 Speed Nut Assembly to Mount Front Cover	† 54-7303-9
11 Screw, #10-24 x .50 Flat	† 52-0209-9
12 Extruded Tape (Not shown)	† 92-0250-9

NOTE: Items 7, 8, 9 and 10 can be ordered as assembly 76-2898-3.

JC1895 REMOTE CONDENSER (USED WITH Q1600 REMOTE ICE MACHINES)

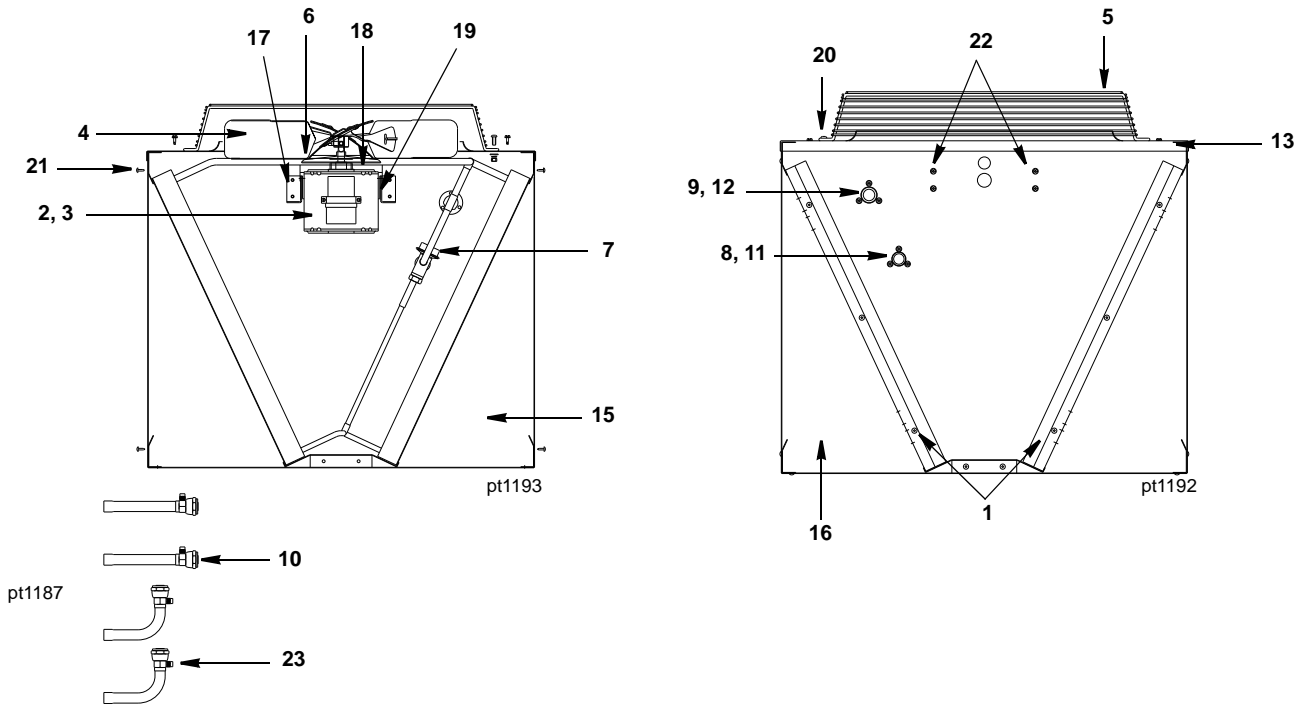

DESCRIPTION

	PART NO.
1 Air Condenser (uses two)	† 88-5089-9
2 Fan Motor (208-230V 50/60 Hz/1 Ph)	† 76-2941-3
3 Fan Motor Run Capacitor (Emerson)	85-0458-3
3 Fan Motor Run Capacitor (Magnatec)	No Longer Available
4 Fan Blade	24-1611-3
5 Fan Guard	34-0064-3
6 Rain Slinger	24-1505-3
7 Head Pressure Control	83-6809-3
8 Coupling – Male, 5/8-18	† 83-6034-3
9 Coupling – Male, 1-1/6-12	† 83-6035-3
10 Female Line Set Coupling Kit (Sold as Finished Goods Sales Kit)	Sales K0129

Miscellaneous – Brackets, Screws, etc.

11 Coupling Mounting Flange (for 5/8-18)	83-6006-3
12 Coupling Mounting Flange (for 1-1/16-12)	83-6005-3
13 Top Cover	601789-1
14 Intentionally Left Blank	
15 Panel – Rear	† 601788-1
16 Panel – Front	† 601787-1
17 Fan Motor Mounting Bracket	† 601768-1
18 Electrical Box Cover	† 601776-1
19 Fan Motor Mounting Screw (5/16-18 x 5/8)	† 50-3565-9
a. Fan Motor Mounting Flatwasher	† 55-7309-9
b. Fan Motor Mounting Lockwasher	† 55-7313-9
c. Fan Motor Mounting Hexnut	54-2975-9
20 Fan Guard Mounting Screw (1/4-20 x 5/8)	† 50-3345-9
a. Fan Guard Mounting Flatwasher	† 55-7304-9
b. Fan Guard Mounting Lockwasher	† 55-4511-9
c. Fan Guard Mounting Hexnut	† 54-2952-9
21 Panel/Condenser Mounting Screw (#8 x 1/2)	† 51-2153-9
a. Panel/Condenser Mounting Lockwasher	† 55-4459-9
22 Screw (#10-24 x 1/2)	† 52-0206-9
23 Valve Cores (used in linesets)	76-2684-3
24 Legs (Not shown)	† 601769-1

† Refer to Cross Reference Guide